

# DC35-12B DATA SHEET



## DC35-12B

35AH@20HR

12-Volt

DEEP CYCLE

Maintenance-Free  
Sealed AGM Battery

Nominal Specifications			
Battery Model	DC35-12B	Rated Capacity	35AH/20HR
Mechanical Specifications			
Group Size	U1		
Overall Height (H)	180±2mm	7.04"	
Container Height (h)	167±2mm	6.54"	
Length	196±2mm	7.72"	
Width	131±2mm	5.16"	
Weight	Approx.11.2kg	24.69lbs.	
Terminal Type	F25- L Terminal		
Terminal Torque	--		
Container Material	ABS: Standard (UL 94-HB)		

Electrical Specifications	
C100	39AH
C20	35AH
C10	32AH
C5	29.0AH
CCA	190A
CA or MCA	230A
HPCA	270A
Max. Discharge Current	450A (5s)
Internal Resistance	5.5mΩ
Reserve Capacity	
Reserve @25 AMPS	35 Minutes
Reserve @75 AMPS	6 Minutes

Temperature Range Specifications	
Operating Temperature Range	Discharge : -15°C ~+ 50°C (5°F~122°F)
	Charge: -15°C ~ +40°C (5°F~104°F)
	Storage: -15°C ~ +40°C (5°F~104°F)
Recommended Operating Temperature Range	+74°F (23°C) to +80°F (27°C)
Self-Discharge	Less than 10% after 90 days, can be stored up to 6 months at 25°C (77°F); Fully recharging is required before usage, For higher temperatures the time interval will be shorter.

Charge Voltages		
Float Charging Voltage	13.5 to 13.8 VDC/unit@ (25°C)	
Equalization and Cycle Service Charging Voltage	14.3 to 14.5 VDC/unit @ (25°C)	
Maximum Charge Current(A)	8.8A	
Charging Temperature Compensation	Cycle use	-4mV/cell/°C
	Float use	-3mV/cell/°C

## BATTERY & TERMINAL DIMENSIONS (All units shown in mm)

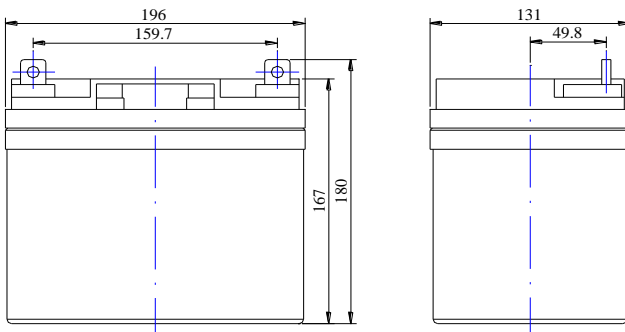

Battery bank spacing required 12.5mm (1/2"inch) minimum

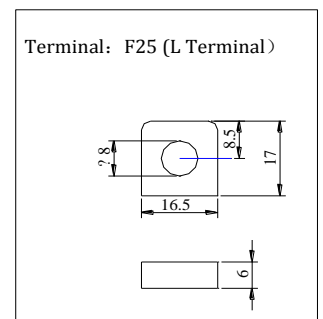
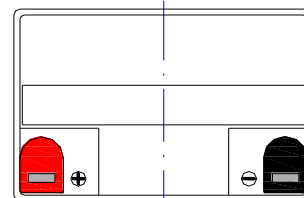

## Constant Current Discharge Rating Amperes @ 77°F (25°C)

Cut off voltage V/cell	15M	30M	45M	1H	2H	3H	5H	8H	10H	12H	20H
1.75V	48	35	26.3	20.6	10.7	7.9	5.6	3.9	3.2	2.7	1.75

Note The above data are average values, and can be obtained with 3 charge/discharge cycles. These are not minimum values.



# DC35-12B DATA SHEET

## Terminal Voltage(V) and Discharge Time

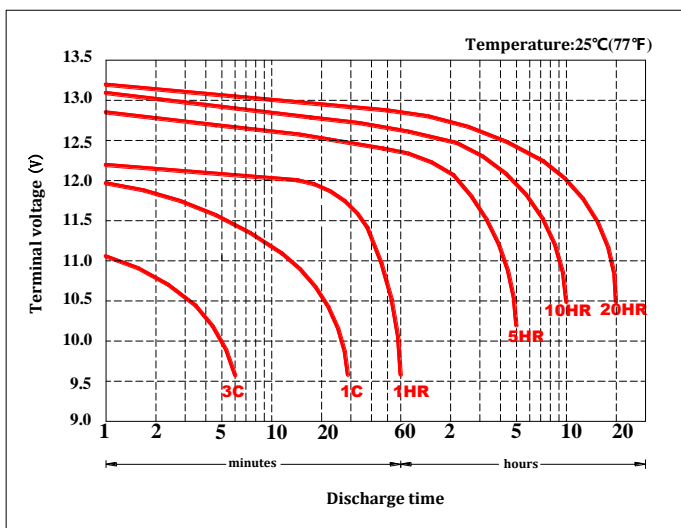

## Duration of discharge vs. Discharge current

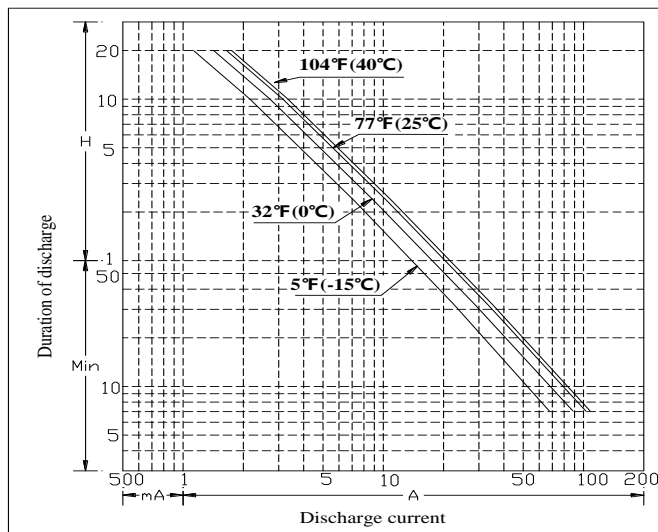

## Percent Capacity vs. Temperature

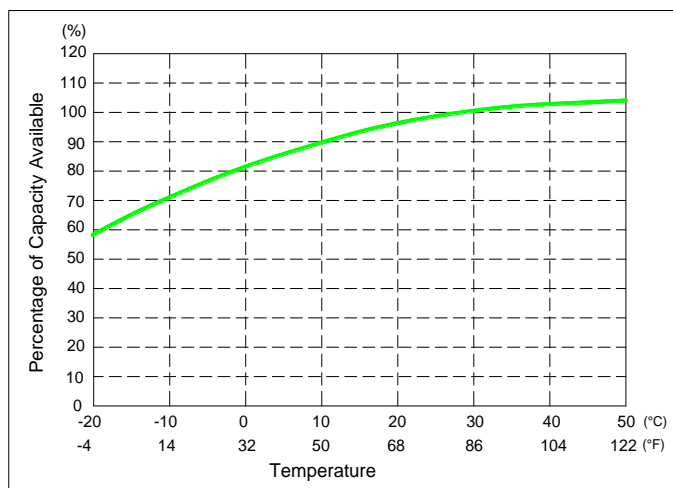

## State of Charge(SOC) vs Open Circuit Voltage(OCV)

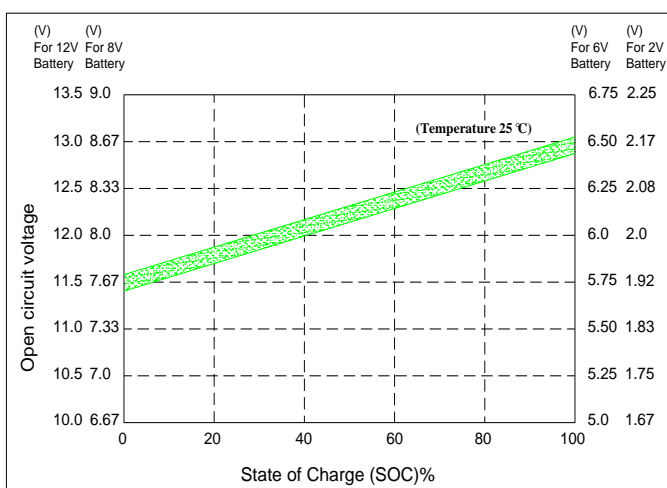

## Capacity Retention Characteristic

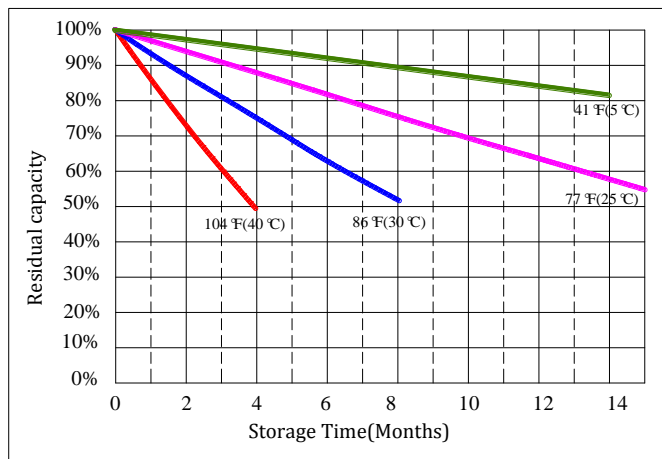

## Cycle Life vs. Depth of Discharge(DOD)

